

## Instructions For Use

### 1st Inject P2.2 Instrument

#### Injector for implantation of 1stQ hydrophilic preloaded intraocular lenses

The IFU is available electronically on our website: [www.1stq.eu](http://www.1stq.eu)

#### Description:

One sterile single use disposable injector for the implantation of 1stQ preloaded foldable hydrophilic intraocular lenses. The injector consists of following parts: the injector body, a cartridge, a pushing rod with a soft tip on it and a red stopper. The estimated corneal incision size is 2.2 mm.

#### Packaging and expiration date:

The instrument is packaged in a protective blister, sterilized by ethylene oxide.

1stQ instruments are sterile unless their primary packaging is damaged. The expiry date is printed on the labels of the outer packaging and the protective blister. Do not use an injector after its expiry date.

#### Indications of use:

The 1stInject P2.2 instrument is indicated for implantation of foldable 1stQ preloaded hydrophilic intraocular lenses into the capsular bag in the posterior chamber of the adult eye after surgical cataract extraction for replacement of the human crystalline lens

#### Contraindications:

There are no known contraindications for the use of the injector during the implantation of a foldable preloaded IOL into the capsular bag.

#### Precautions and warnings:

The 1st Inject P2.2 Instrument is dedicated for use exclusively with 1stQ preloaded foldable hydrophilic Basis IOL. Injector and IOL are packaged individually. Before using the devices please read both Instructions for Use carefully.

- Examine the labels on the packaging carefully for information about the injector model and expiration date. Injectors must not be used after the expiration date.
- Do not resterilize any part of the instrument by any method.
- Do not re-use. Any occasional re-use must be avoided as it may pose serious health risk either by non-sterility or by any mechanical defect caused by the previous use.
- Do not use the instrument if the packaging is damaged or wet and the sterility of the device may have been compromised.
- Store the unopened injector packaging in a dry place, away from moisture and direct sunlight at room temperature (15-35°C) and a minimum of 35% relative humidity.
- A high level of surgical skills is required to implant intraocular lenses. The surgeon should have observed and/or assisted at numerous implantations and successfully completed one or more courses on IOL implantation before attempting to implant intraocular lenses.
- Patients should be advised that unexpected outcomes may necessitate additional surgical intervention.

**Directions for use:**

- Open the outer package to remove the blister containing the injector instrument and verify that the information on the blister is consistent with the outer package labelling (e.g. model, and lot number). At the same time ensure that the appropriate, unexpired, sterile hydrophilic preloaded 1stQ Basis IOL is available.
- Open the blister and remove the injector in a sterile environment.
- Prepare the IOL container as described in its Instructions for Use (see also Figure 1).
- Align the arrows on the injector's red stopper and the open wet IOL container for correct positioning (Figure 2).
- Insert the injector with a firm downward motion until it clicks (Figure 3).
- Pull out the injector (Figure 4) and check that the lens holder is loaded in the injector.
- Carefully release the cartridge nozzle from the hook. Make sure you do not damage the nozzle tip. Fold up the cartridge nozzle by 180 degrees until it snaps into place (Figure 5).
- Push the red stopper forward until it clicks to secure the cartridge nozzle and at the same time to unblock the pushing rod (Figure 6). Avoid premature pushing of the rod which is freely movable after this action.
- Introduce the cannula (23G) of a syringe filled with viscoelastic material into the small aperture in front of the red stopper. Inject the viscoelastic material through the aperture (Figure 7) and fill the cartridge nozzle halfway up. Balanced Salt Solution alone should not be used as lubricant.
- With the nozzle tip bevel facing down, inject the IOL in a controlled manner (Figure 8). Don't use too much pressure. Anticipate a slight initial resistance. Too much resistance could indicate a trapped lens. If the IOL blocks the injector, discard the injector and the IOL.
- The entire injection should be one continuous process without interruption. Never pull the plunger back; otherwise the haptics might become damaged.
- When the lens exits the cartridge nozzle, stop pressing the plunger.
- Discard the injector after use.

**Description of Figures:**

1. Open the container of the preloaded IOL (Figure 1).
2. Align the arrows on the injector's red stopper and the open wet IOL container for correct positioning (Figure 2).
3. Insert the injector with a firm downward motion until it clicks (Figure 3).
4. Pull out the injector (Figure 4) and check that the lens holder is loaded in the injector.
5. Carefully release the cartridge nozzle from the hook. Make sure you do not damage the nozzle tip. Fold up the cartridge nozzle by 180 degrees until it snaps into place (Figure 5).
6. Push the red stopper forward until it clicks to secure the cartridge nozzle and at the same time to unblock the pushing rod (Figure 6). Avoid premature pushing of the rod which is freely movable after this action.
7. Introduce the cannula (23G) of a syringe filled with viscoelastic material into the small aperture in front of the red stopper. Inject the viscoelastic material through the aperture (Figure 7) and fill the cartridge nozzle halfway up. Balanced Salt Solution alone should not be used as lubricant.
8. Push the plunger to inject the IOL (Figure 8)

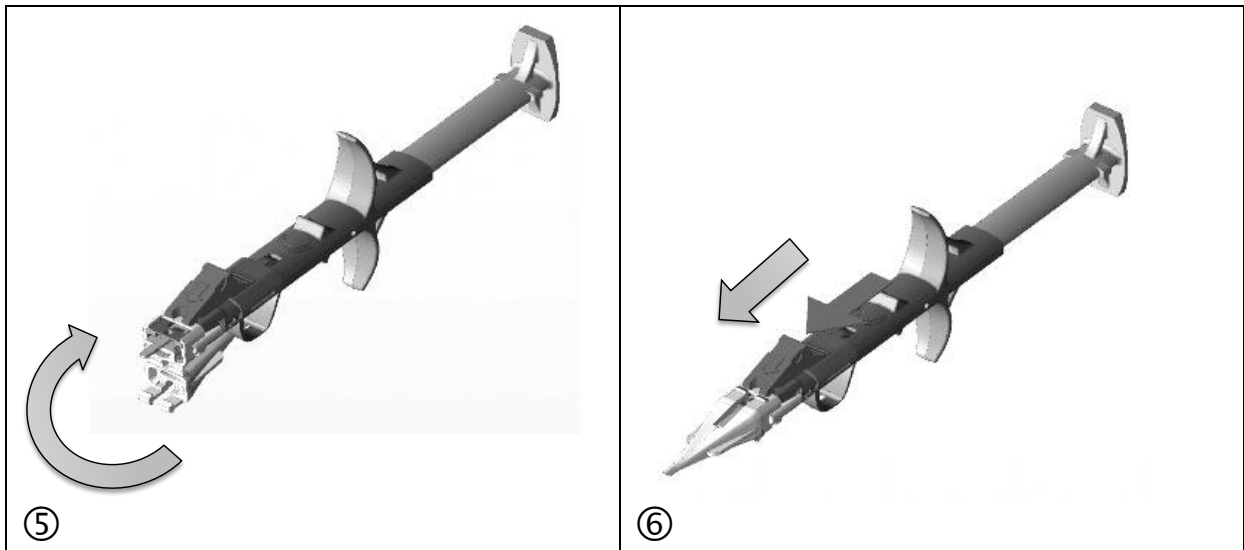
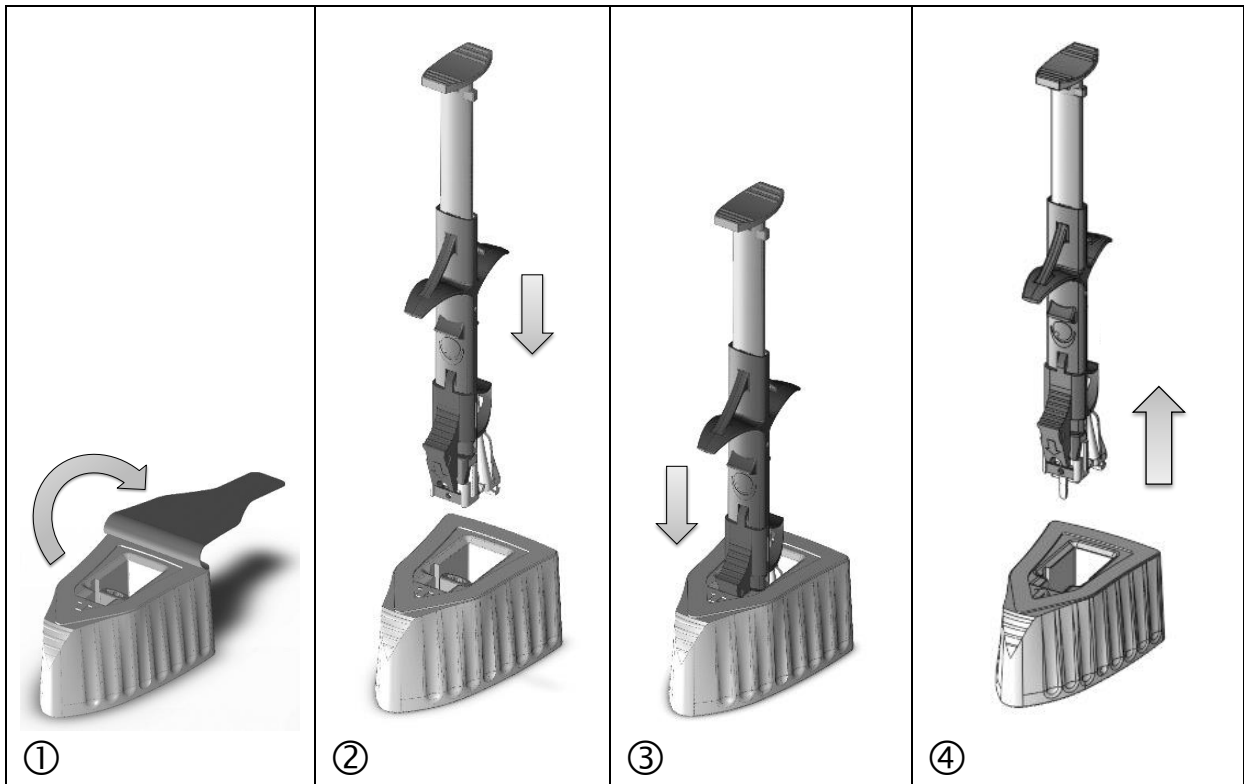

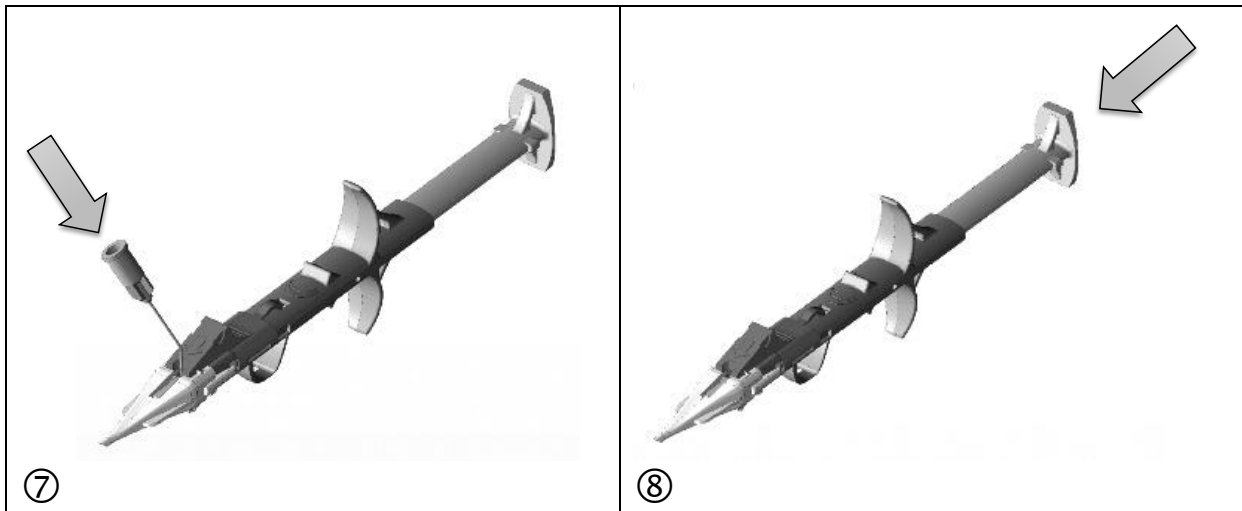

**Interactions:**

There are no known interactions between the injector and medicaments. In reasonably foreseeable environmental conditions, no significant interaction or possible damage caused by exposition to magnetic fields, external electrical influences, electrostatic discharge, pressure or variation in pressure, thermal ignition sources and acceleration is known.

**Possible complications:**











As with any surgical procedure, there is risk involved. The most common potential complications and undesirable effects accompanying cataract or implant surgery are described in the Instruction for Use of the IOL.

**Reporting customer complaints and return of product:**

Customer complaints including quality complaints, adverse events and other medical device related observations should be reported to 1stQ without delay. A report describing the details of the complaint/event, the applied therapy, the product type, LOT/serial number of the medical device used is requested.

If possible, return the medical device and/or its original container and/or any part of the packaging, as well as the used injection instrument to 1stQ or to your local distributor.

**Symbols used:**

	Do not resterilize		Serial number
	For single use		Sterilized using ethylene oxide
	Keep away from sunlight		Do not used if package is damaged
	Keep dry		Manufacturer
	Use by (date)		CE certified
	Consult Instructions for use		

**Liability:**

1stQ does not bear any responsibility for improper model selection by the physician, for improper handling, use, surgical technique applied or for any other iatrogenic error caused by the implanting surgeon.

This product is subject to change with or without prior notice. Improvement changes may be made in specification, shape and material.

All translations of this text are derived from the original English text. Should you face any discrepancy or problem in interpretation, please consult the English version for guidance.

The content of this document is subject to change without prior notice.

**Manufacturer:**



1stQ GmbH                      Tel: +49 621 7895 3790  
 Harrlachweg 1                Fax: +49 621 7895 3791  
 68163 Mannheim            www.1stq.eu  
 Germany                        info@1stq.de